

---

# RAC 12c Cache Fusion Internals

---

By

Riyaj Shamsudeen

# Me



**ORACLE**  
ACE Director

- 23+ years using Oracle products
- OakTable member
- Oracle ACE Director
- Specializes in RAC, performance tuning and Internals.
- Slowly in to BigData
- [rshamsud@orainternals.com](mailto:rshamsud@orainternals.com)
- [orainternals.wordpress.com](http://orainternals.wordpress.com)
- Web: [www.orainternals.com](http://www.orainternals.com)

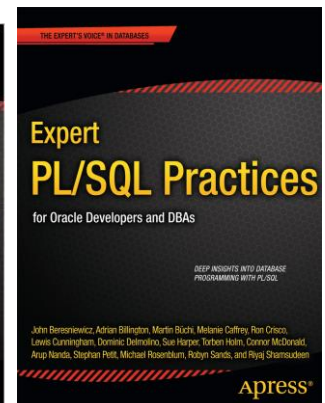
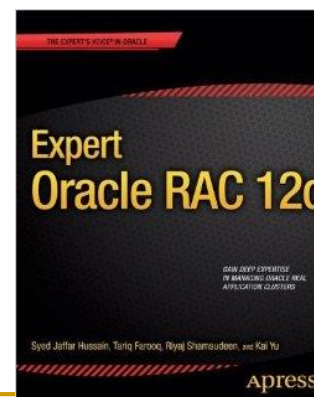
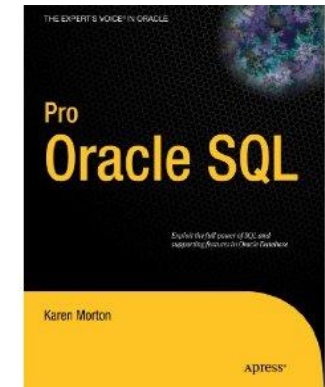
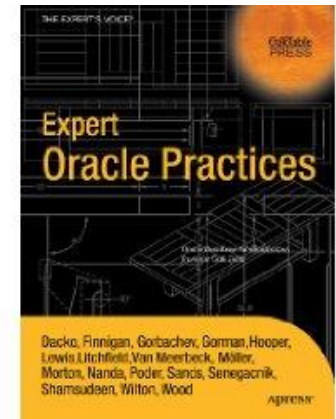

# Process architecture

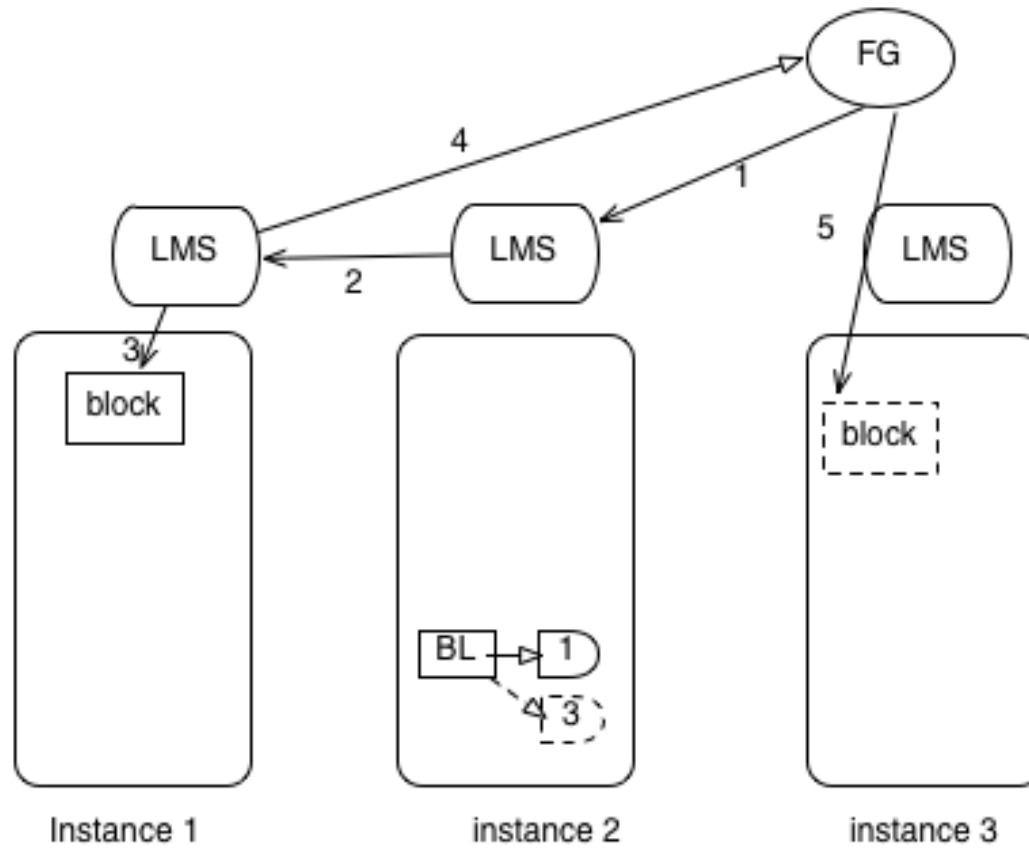

# Wireshark demo

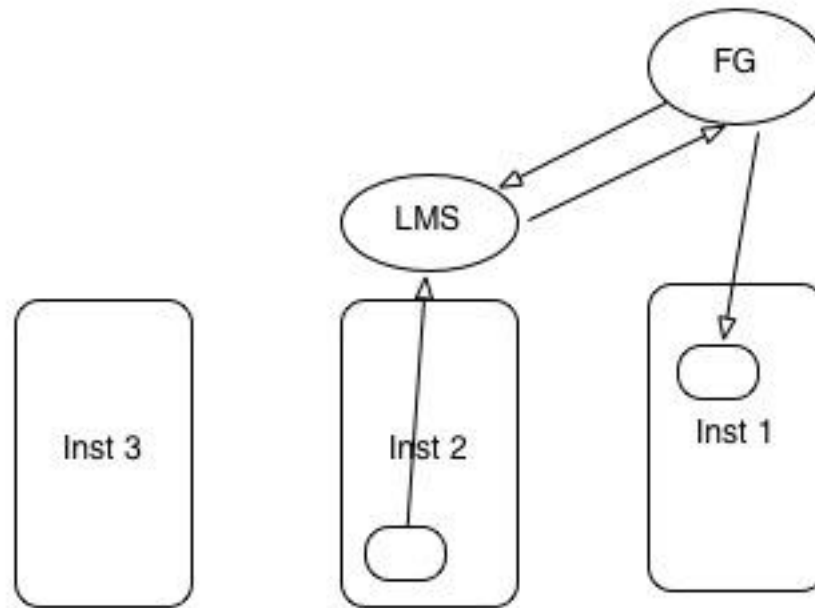

# MTU

- MTU defines Maximum Transmission Unit of a packet. Limits the size of a packet, default is ~1500 bytes.
- Transfer of an 8K UDP => Transfer of 6 IP packets

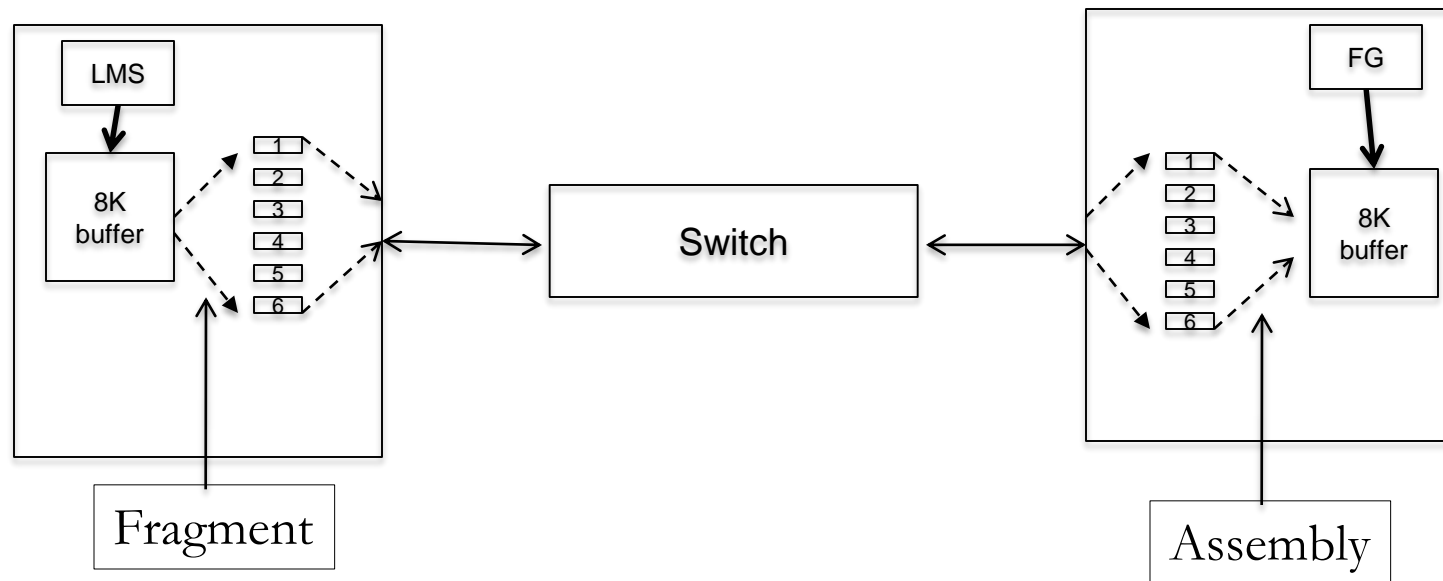

Demo using wireshark

## BL resources

- BL locks protects database blocks(in RAC).
- BL resource follows a naming convention of [Block\_id ] [file\_id], BL

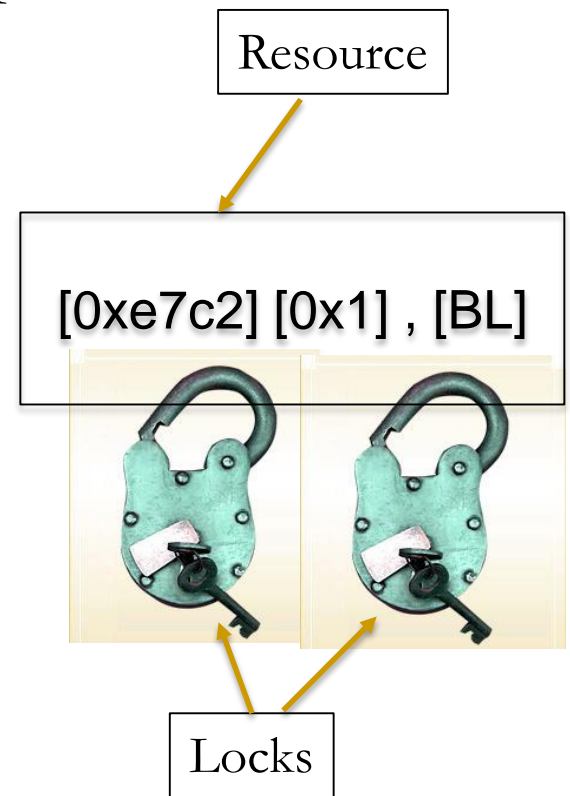
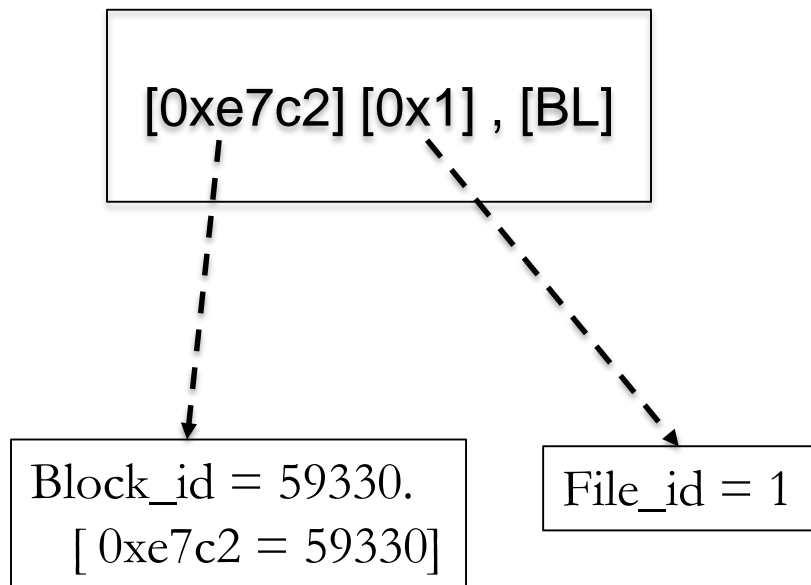

# Single block read

- Block is not in any buffer cache. LMS grants a PR mode lock on the resource and asks FG to read from the disk.

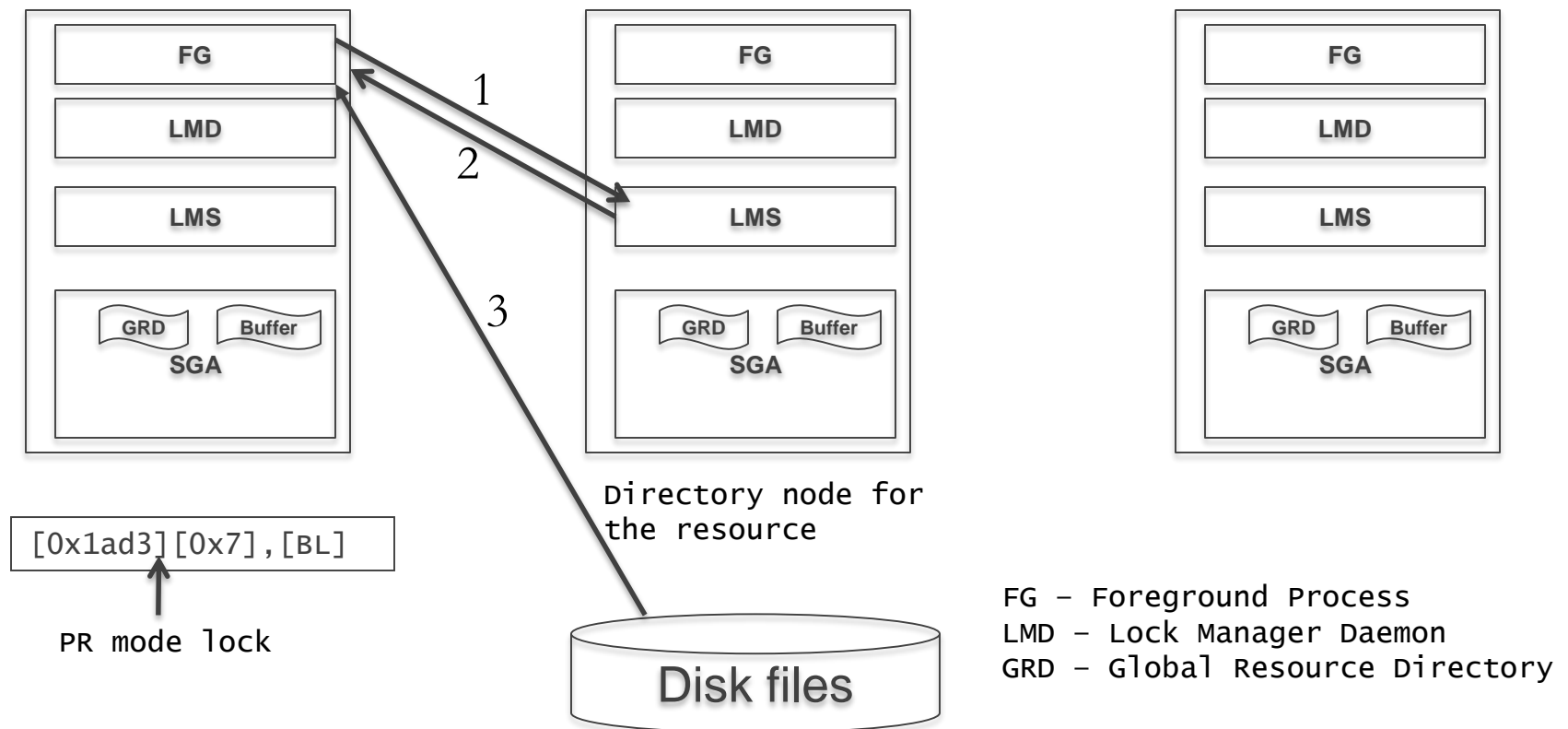

Demo: demo\_01a.sql

# Trace lines

WAIT #18446741324875049632: nam='gc cr grant 2-way' ela= 499 p1=7 p2=6867 p3=1 obj#=76484  
tim=4597940025

WAIT #18446741324875049632: nam='db file sequential read' ela= 758 file#=7 block#=6867 blocks=1  
obj#=76484 tim=4597941129

## ■ PR mode

KJBLNAME	KJBLNAME2	KJBLGRANT	KJBLROLE	KJBLREQUES
[0x1ad3][0x7],[BL]	6867,7,BL	KJUSERPR	0	KJUSERNL



# GCS structures

A resource structure created in the directory instance, a lock created in instance 2

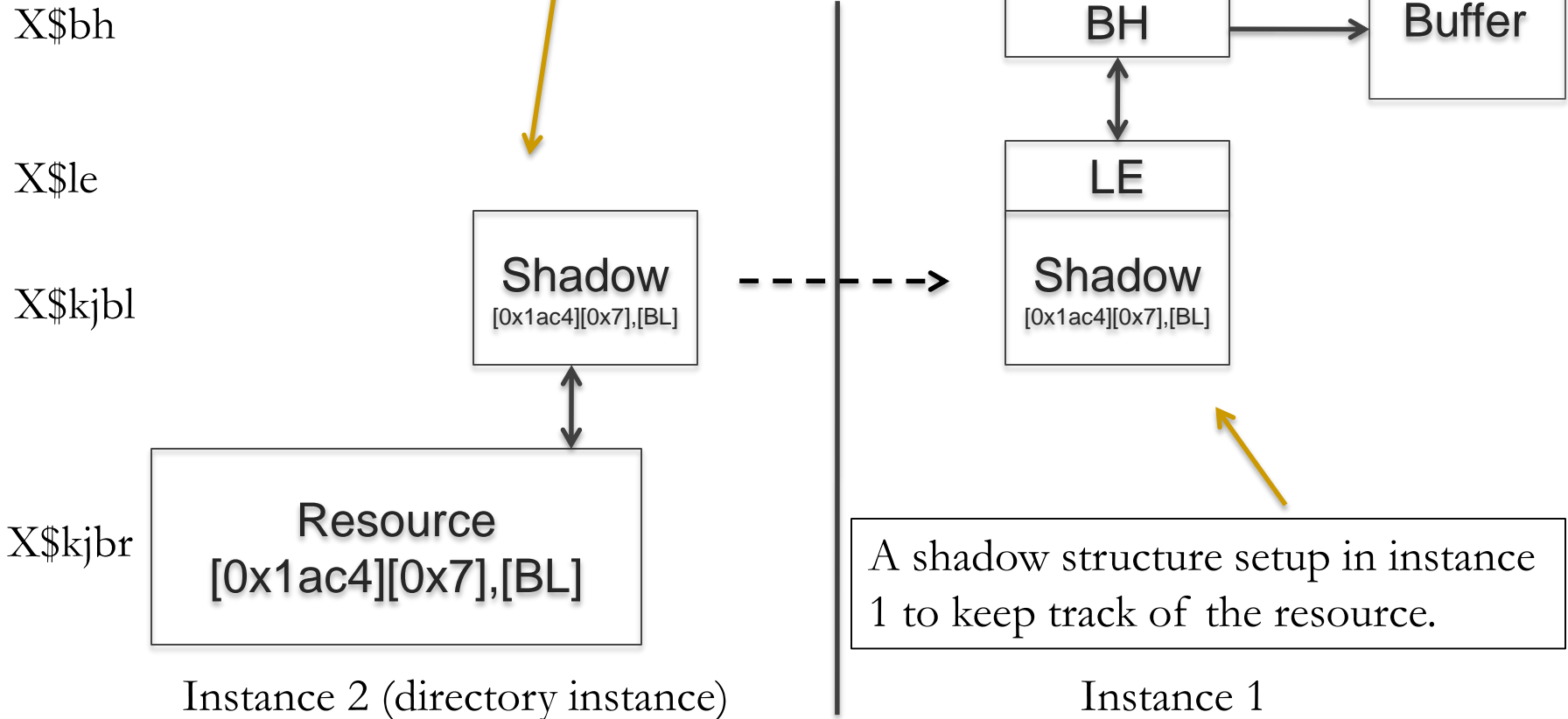

Demo: tc\_one\_row.sql, gcs\_locks.sql gcs\_resources.sql

# Single block transfer -2 way

- Block is in the directory instance in a compatible mode. Both block transfer and grant performed by the LMS process running in instance 2.

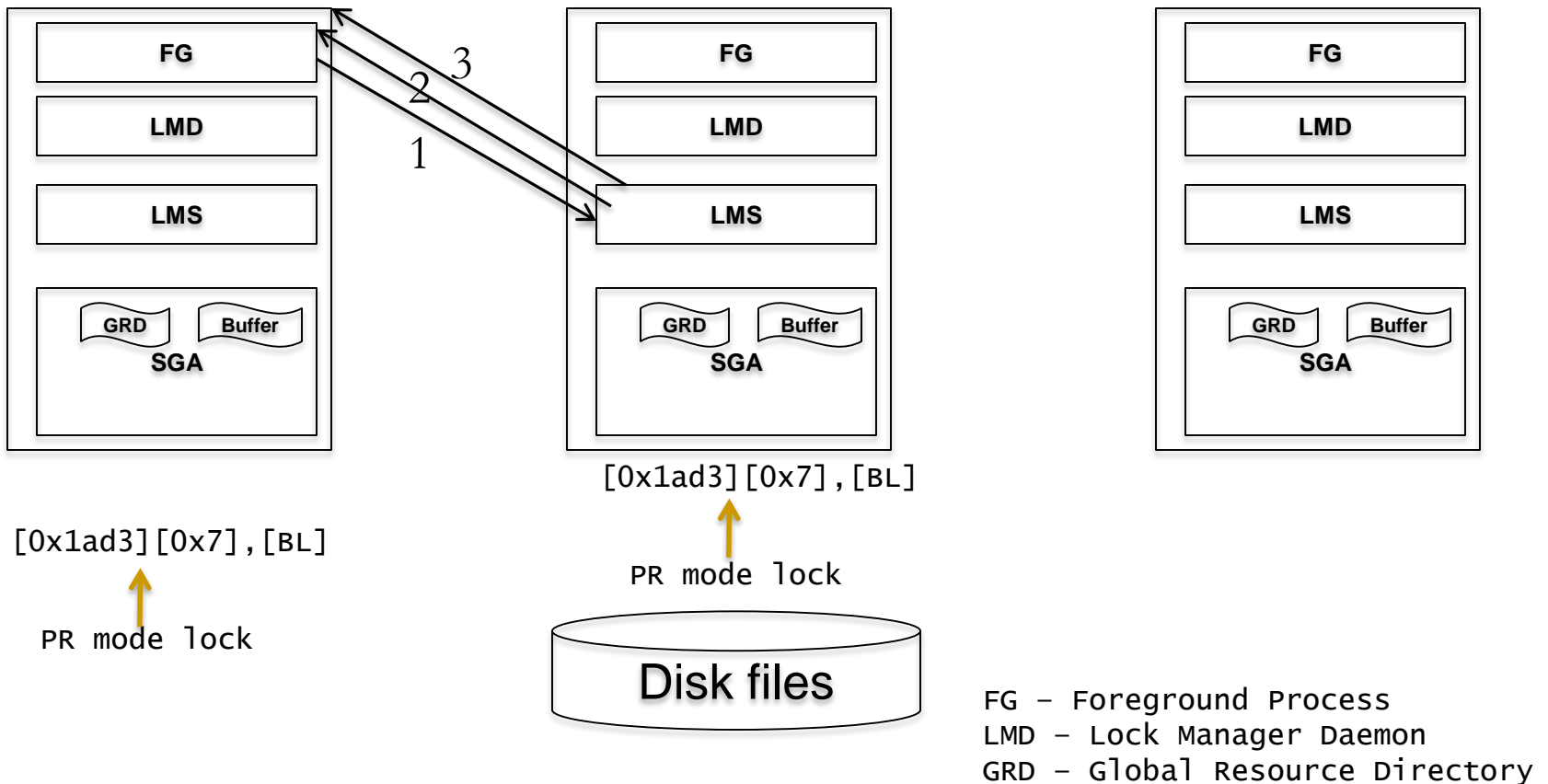

# GCS Directory instance

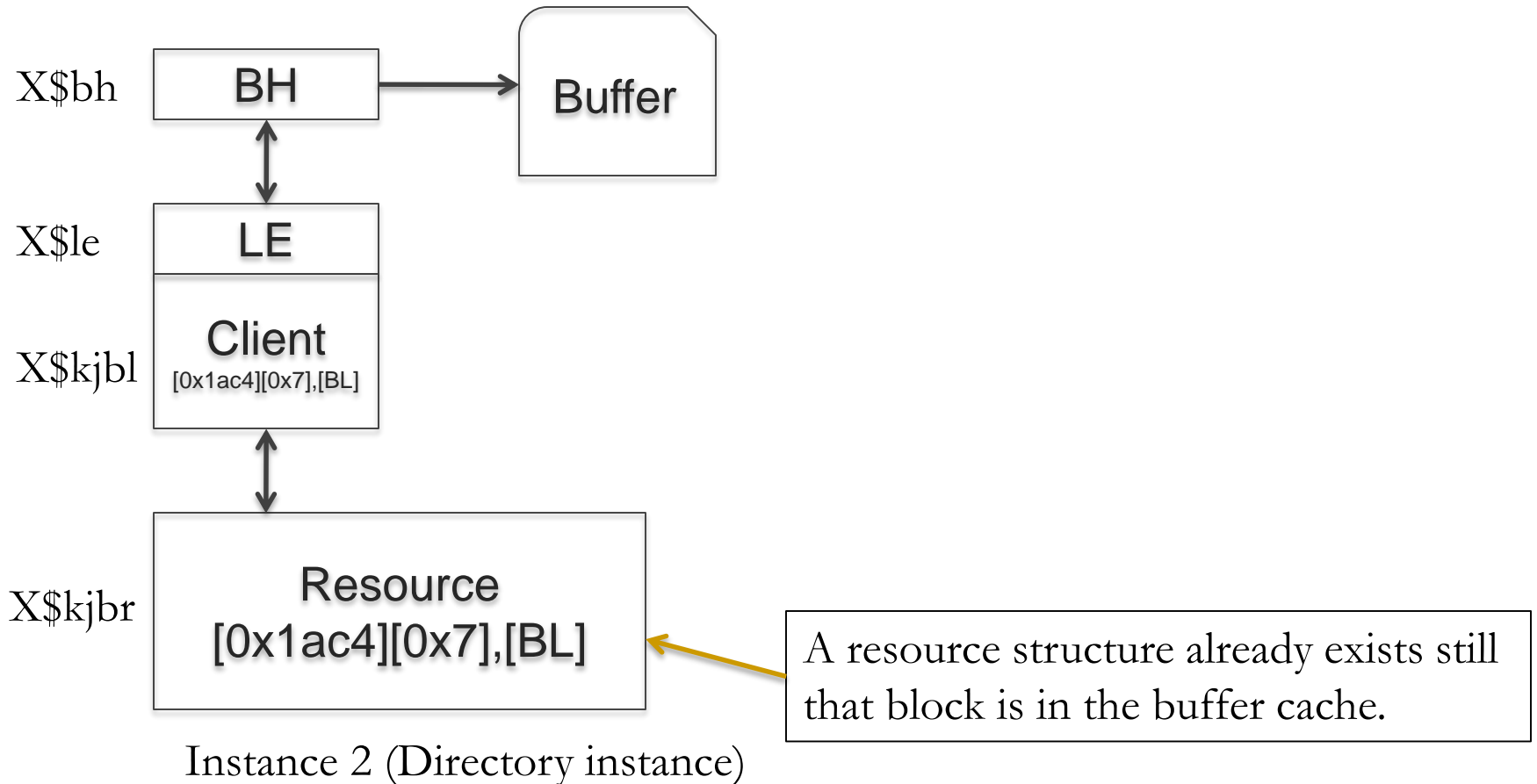

Demo: demo\_01a.sql and demo\_01b.sql

# GCS shadows

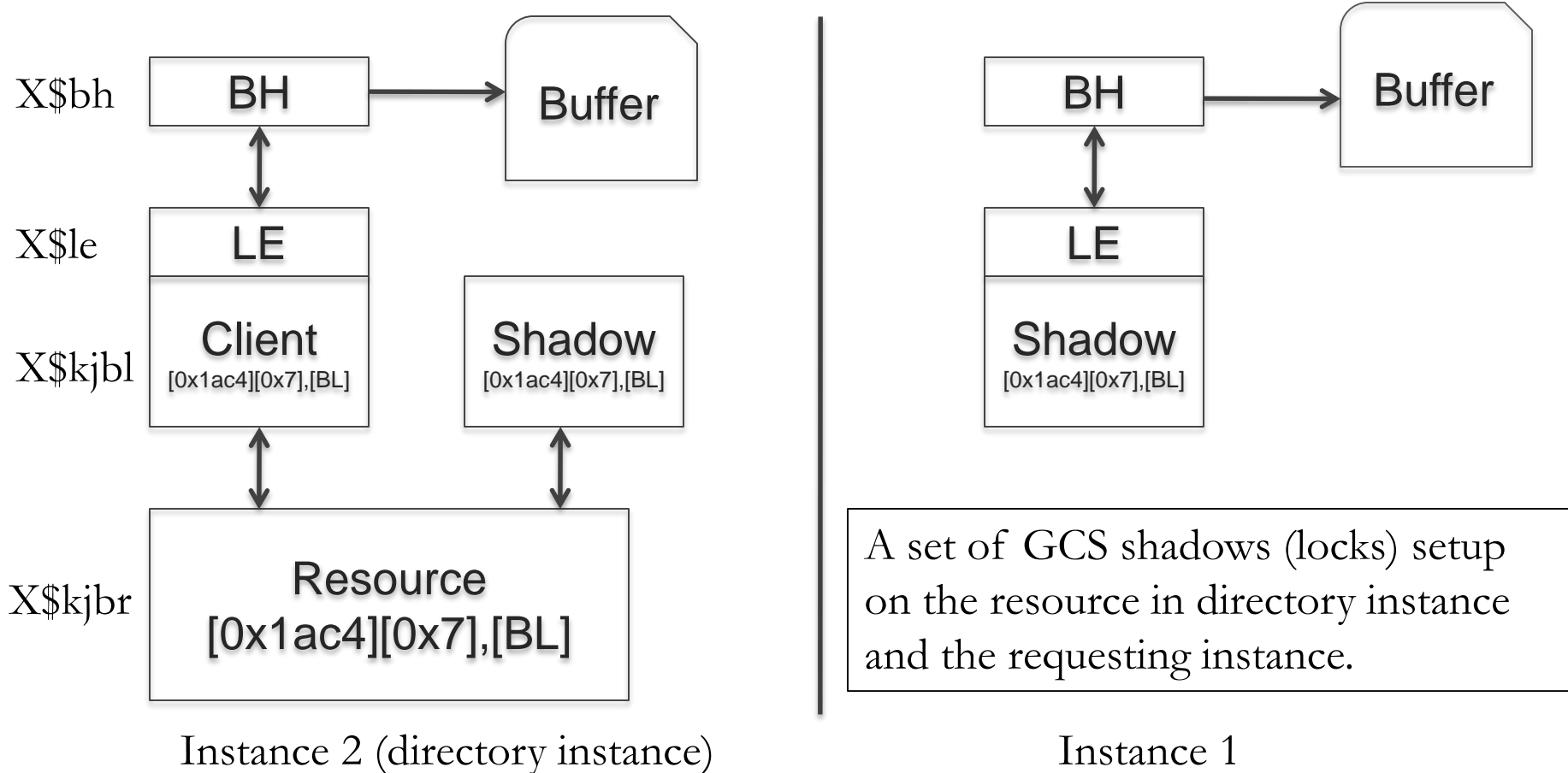

Demo: demo\_01a.sql and demo\_0a.sql

# Single block transfer -3 way

- Block is in the buffer cache of instance 3. Instance 2 is the directory instance of the resource. LMS process transfers the blocks from instance 3 over the interconnect.

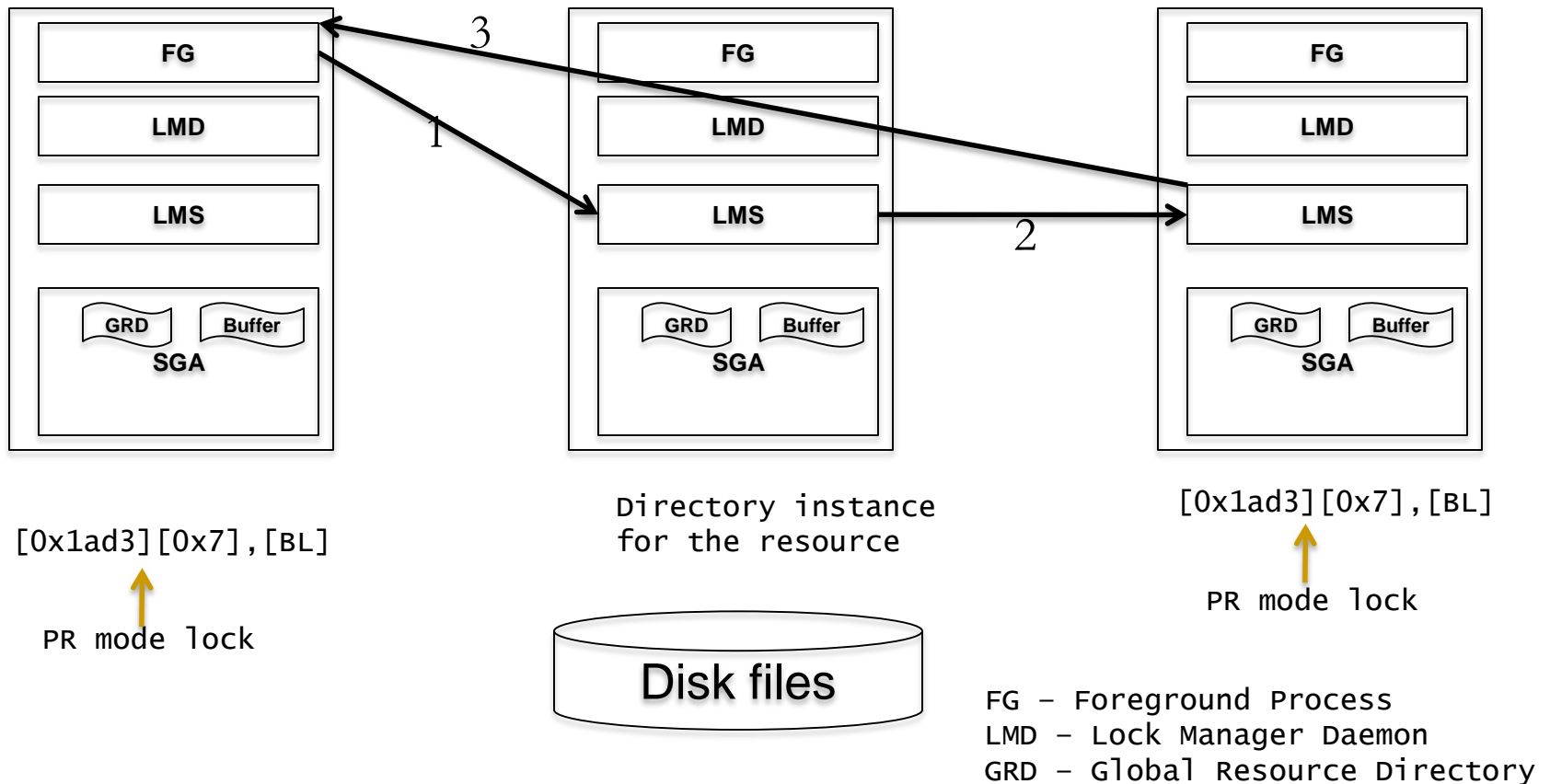

---

## CUR mode

- Concurrent changes to the same block.
- Row level lock vs BL lock.
- EX grants must be acquired to change blocks.

---

Demo: upd\_one\_row\_100.sql, upd\_one\_row\_101.sql

## CUR mode

- Two pending transactions in the same block.

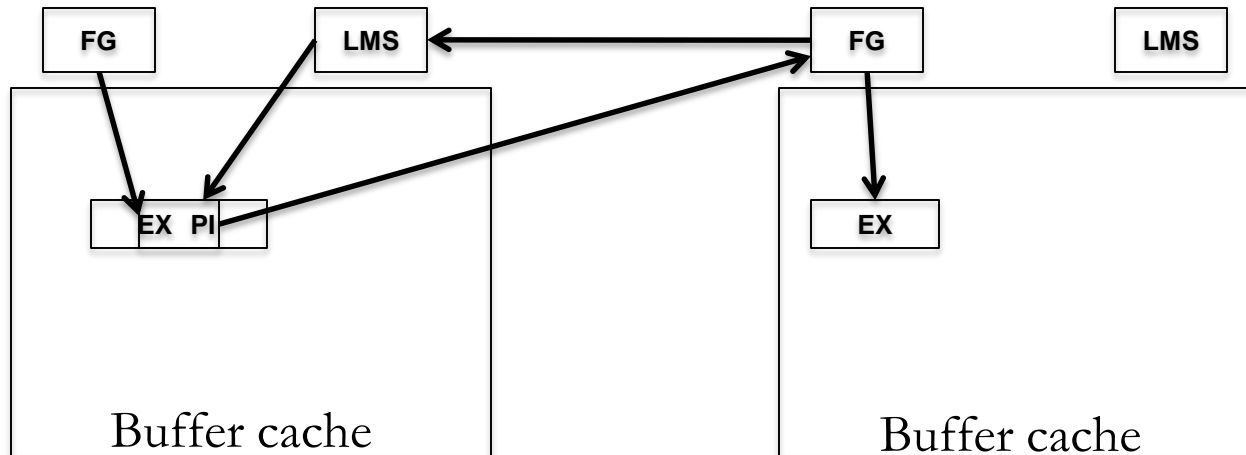

# Buffer changes

- Changes under EX mode.
- Downgrade by other instances.

KJBLNAME	KJBLNAME2	KJBLGRANT	KJBLROLE	KJBLREQUES
[0x1ac4][0x7],[BL][ext 0x0,0x0	6852,7,BL	KJUSEREX	0	KJUSERNL

Enter value for block: 6852

STATE	MODE_HELD	LE_ADDR	DBARFIL	DBABLK	CR_SCN_BAS	CR_SCN_WRP	CLASS
1	0	000000006D3E3AB0	7	6852	0	0	1



## CR buffers

- Instance 1 acquired EX mode lock.
- Instance 2 requests the block, and LMS in instance 1 ships CR copy.

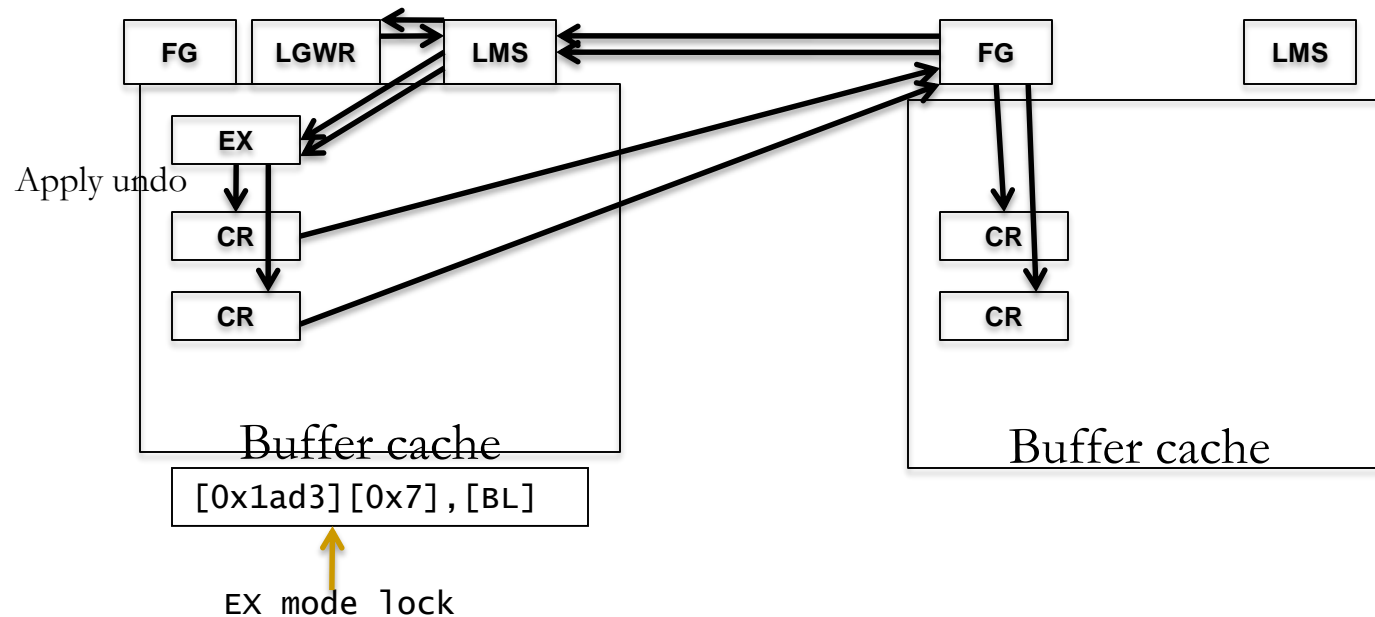

Demo, upd\_100.sql , buffer\_state, tc\_one\_row

---

## Busy

- *gc cr block busy, gc current block busy*
- LMS constructed buffer applying undo records.
- Excessive \*busy events = No application affinity.
- Application affinity will reduce \*busy events as the buffers will be modified in the same instance.

---

## Congested

- Congested wait events also imply concurrency, but at an higher level.
- If LMS process can not get to a request in 1ms time, then the response for the request will be marked with ‘congestion’ wait event.
- Review RT priority and LMS session/process metrics.

# gc cr grants 2-way

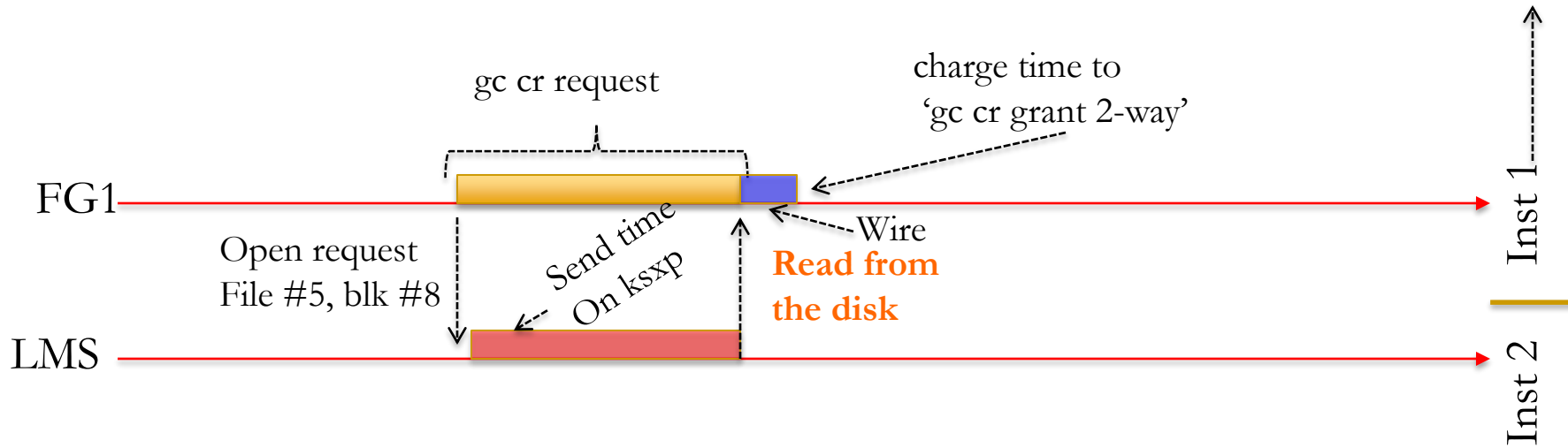

# Why DRM?

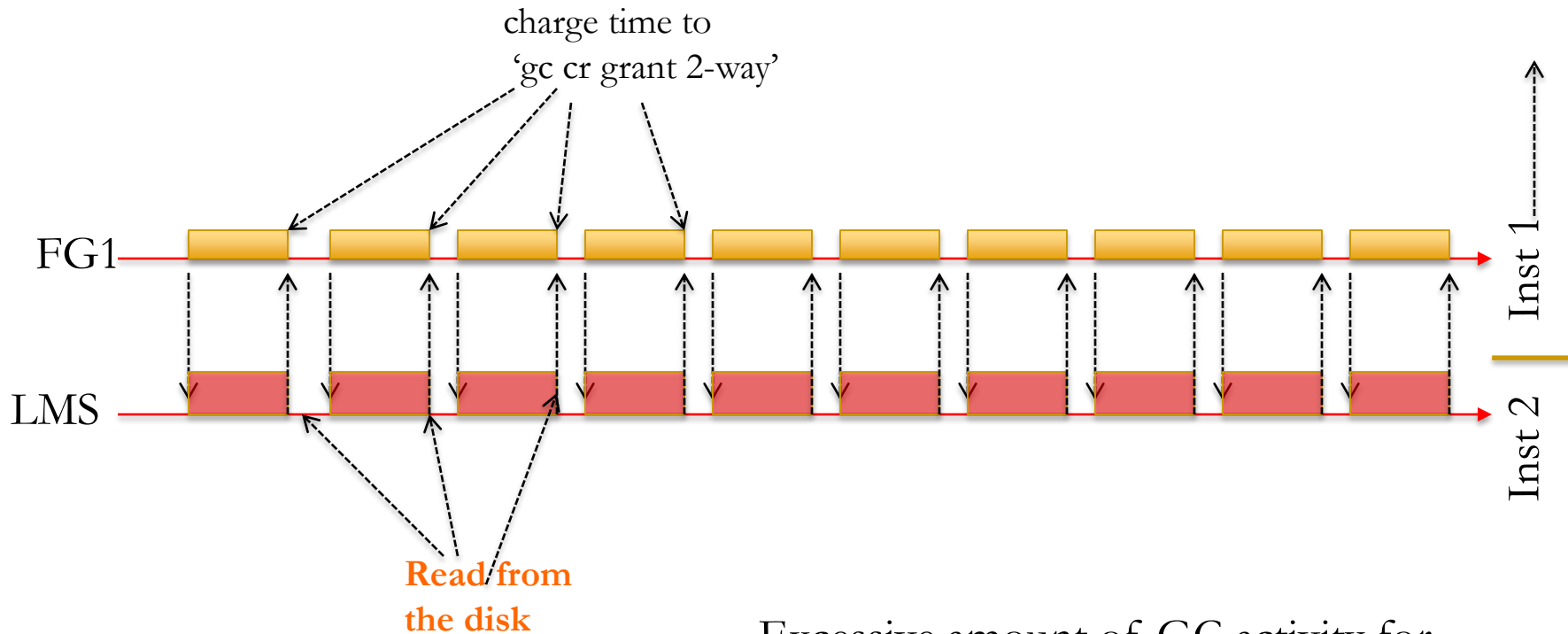

Excessive amount of GC activity for One object!

Demo: remaster demo. Refer [sqldeveloper](#)

# DRM (11g)

In 11g, all resources are frozen during the reconfiguration.

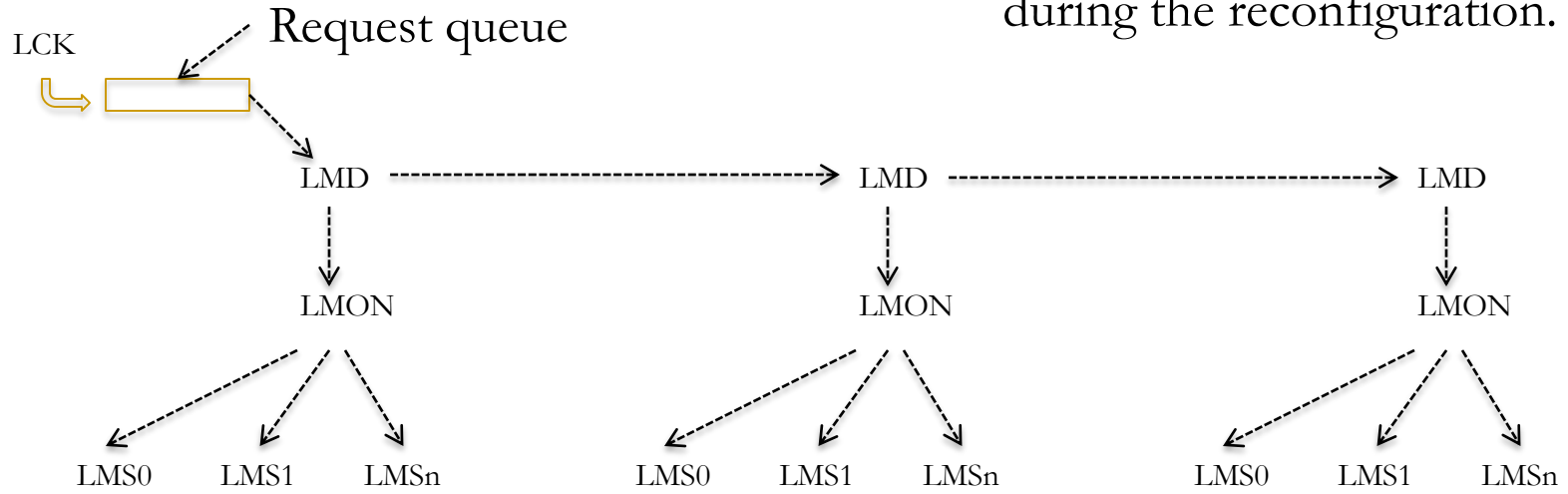

Resources

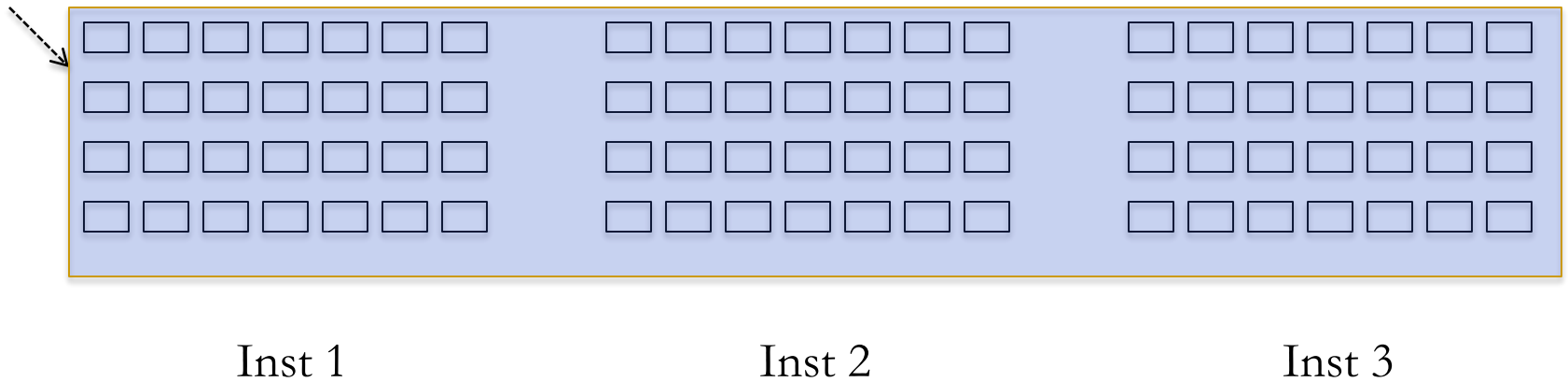

# DRM (12c)

In 12c, only set of resources in a window is frozen.

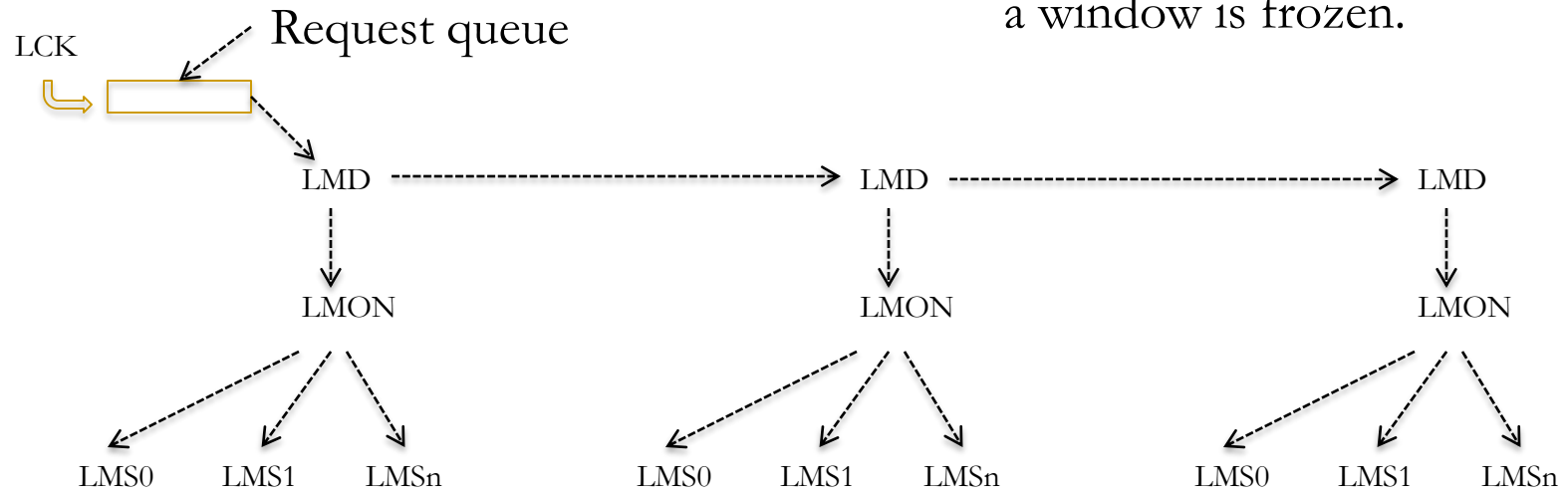

## Resources

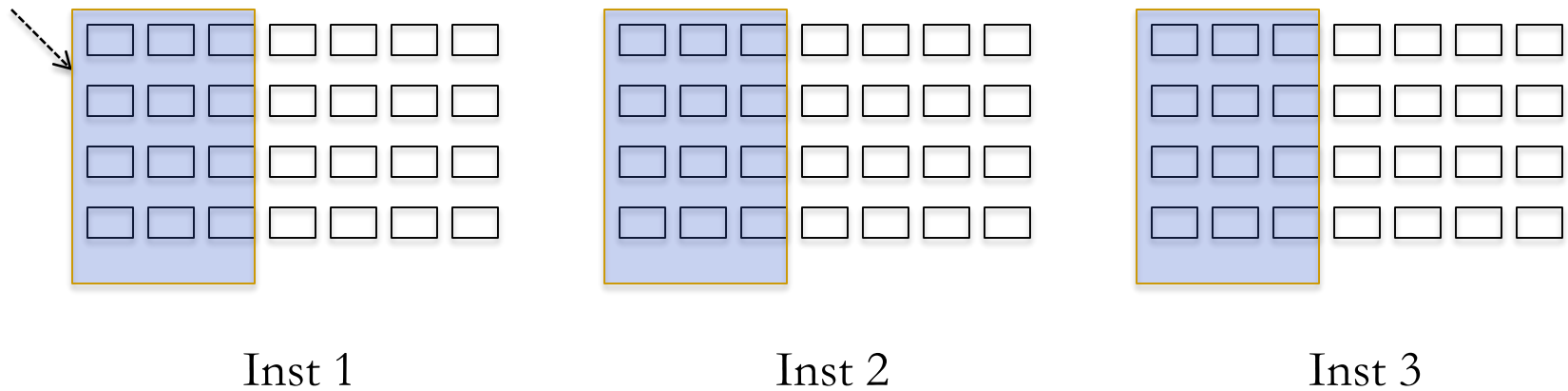

## Resource names

- From 12 onwards, resource names are coded with con\_id.

```
select resource_name from gv$ges_resource
where resource_name like '[0x15f29][0x0],[TM]%'
/
```

```
RESOURCE_NAME
```

```
-----
```

```
[0x15f29][0x0],[TM][ext 0x3,0x0] <- hrdb1 PDB - GSTEST table -object_id=89897
[0x15f29][0x0],[TM][ext 0x4,0x0] <- hrdb2 PDB - GSTEST table -object_id=89897
```

- Comes handy if you are debugging RAC trace files, to identify the PDB generating the errors.



# THANK YOU

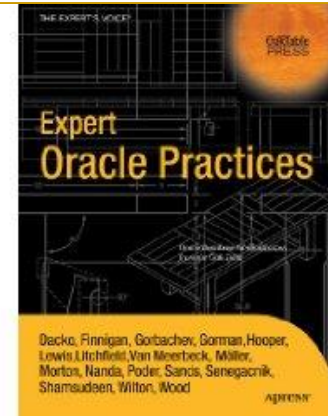
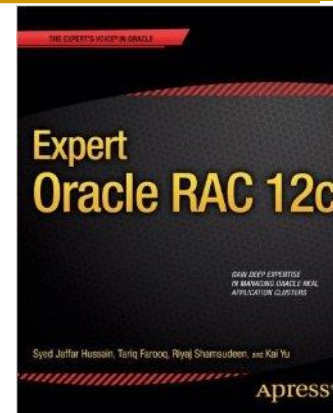

- **Email:** [rshamsud@orainternals.com](mailto:rshamsud@orainternals.com)
- **Blog :** [orainternals.wordpress.com](http://orainternals.wordpress.com)
- **Web:** [www.orainternals.com](http://www.orainternals.com)

